

# CB SERIE 100-1500

## CENTRIFUGALPUMPE

- Ydelse: max 600 l/min. Løftehøjde: max 98 m. VS
- 0,75-11 kW el-motor, 1x230/3x400V
- 1"- 2" tilslutning indløb, 1"-1"1/4 udløb
- Mekanisk aksel tætning kul/keramisk
- Indgangstryk max 11 bar
- Max. temperatur 90°C
- Støbejern, Vægt 15,3 kg - 93 kg
- To trins pumpe for højt tryk og stabil ydelse. Effektiv til vandingsanlæg og trykforøgning.



# CENTRIFUGALPUMPE CB SERIE

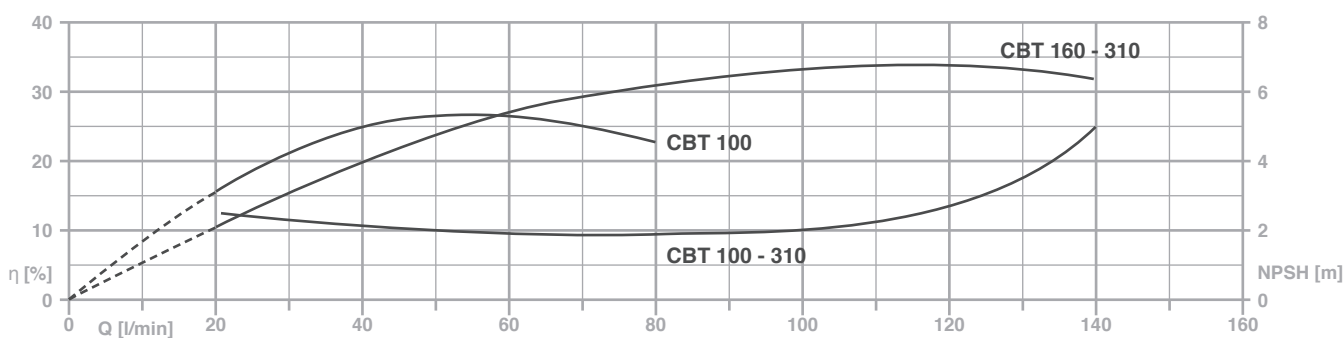
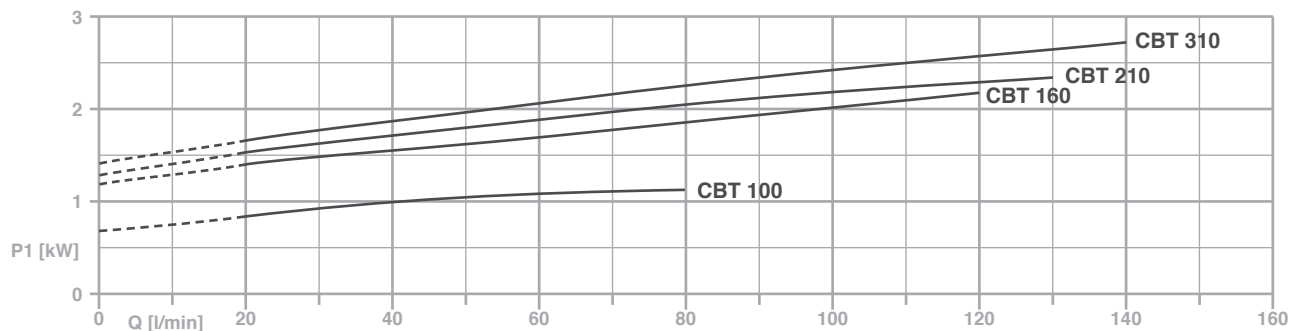
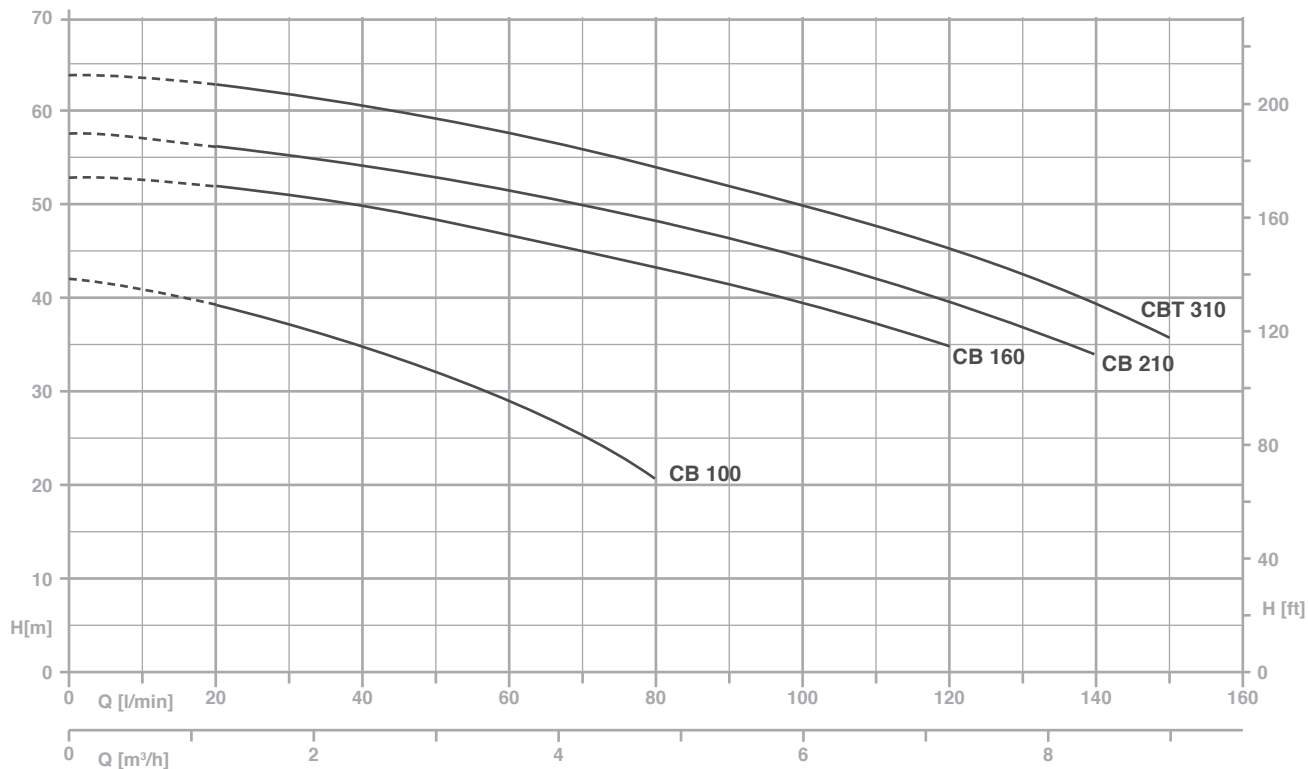

TYPE		P2		P1 (kW)		AMPERE		Q (m³/h - l/min)										
1~	3~					1~	3~	0	0,6	1,2	1,8	2,4	3,6	4,8	6	7,2	8,4	9
						0	10	20	30	40	60	80	100	120	140	150		
		(HP)	(kW)	1~	3~	1x230 V 50 Hz	3x400 V 50 Hz	H (m)										
CB 100	CBT 100	1	0,74	1,17	1,15	5,4	2,4	42	40,8	39,4	37,4	34,7	29,2	21	-	-	-	-
CB 160	CBT 160	1,5	1,1	2,30	2,20	10,2	4,1	53	52,5	52	51	50	46,9	43,3	39,7	35	-	-
CB 210	CBT 210	2	1,5	2,60	2,45	11,5	4,8	57,3	56,9	56	55,1	54	51,5	48,4	44,4	39,5	34	-
-	CBT 310	3	2,2	-	2,80	-	5,2	64	63,5	63	61,9	60,6	57,7	54,1	50	45,4	39,4	36

# CENTRIFUGALPUMPE CB SERIE

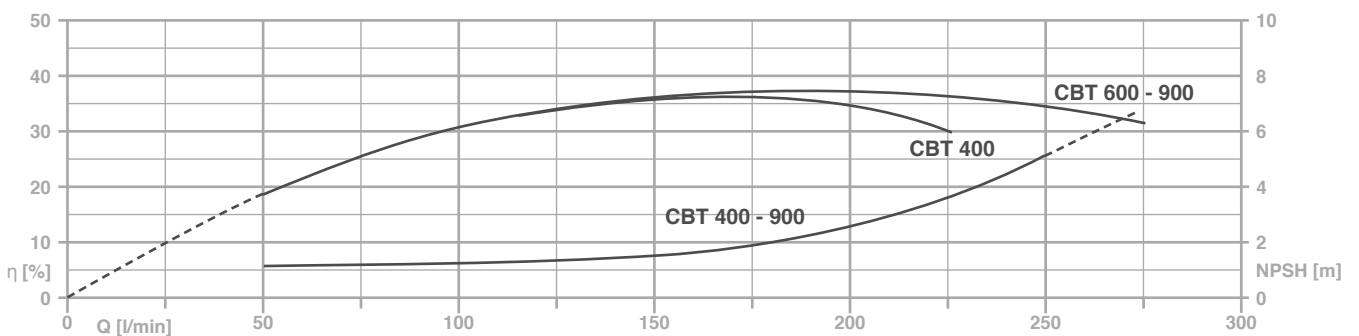
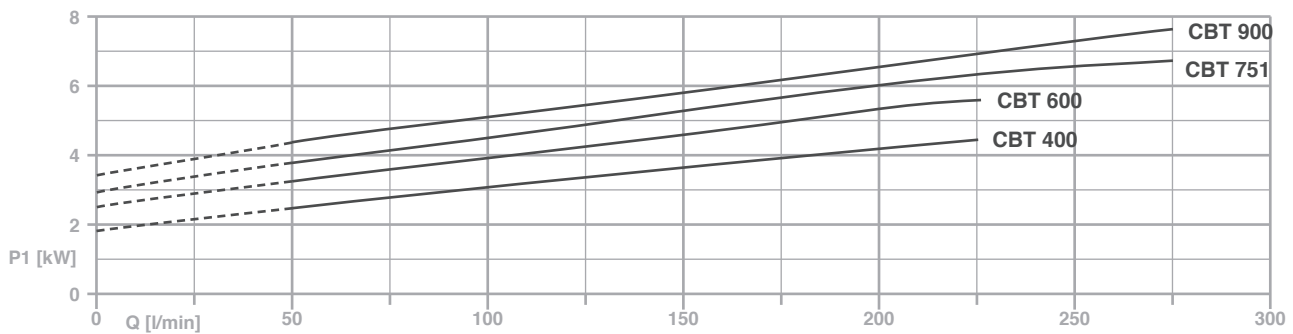
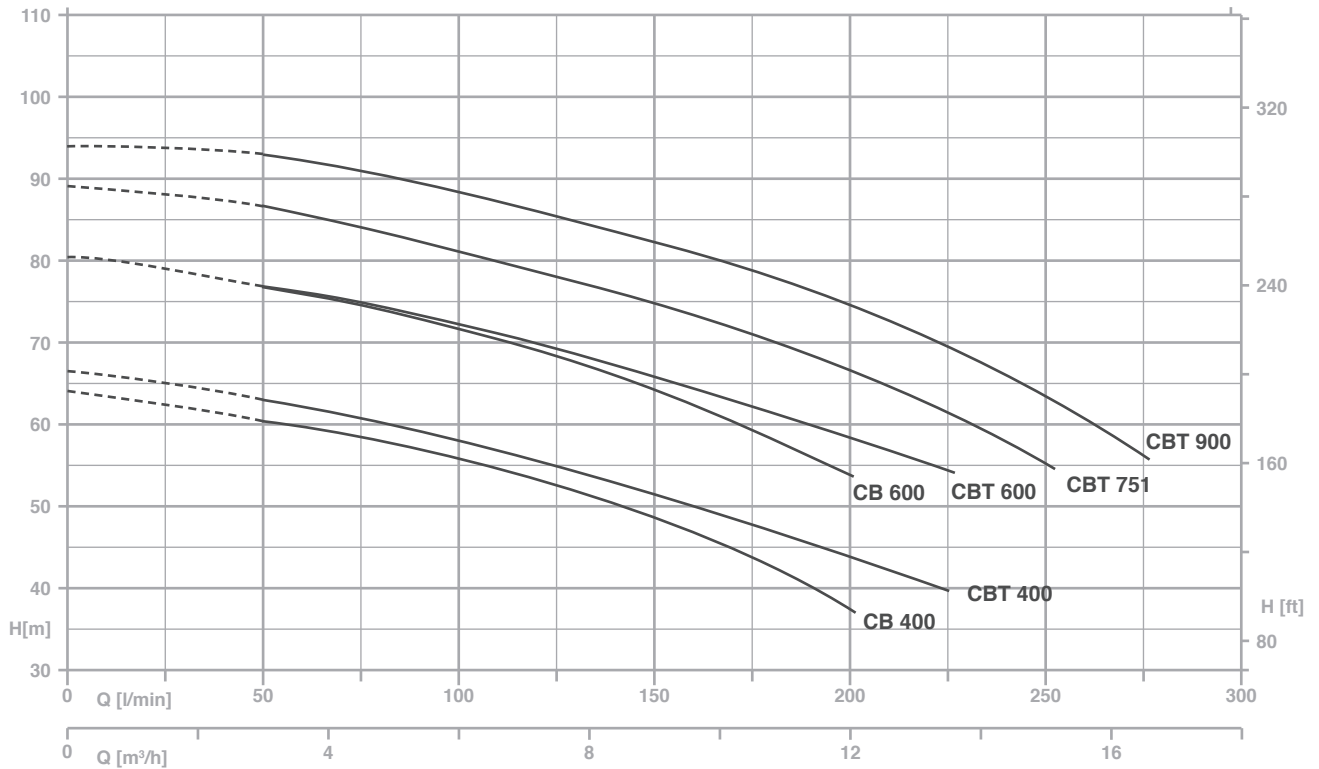

TYPE		P2		P1 (kW)		AMPERE		Q (m³/h - l/min)															
1~	3~	(HP)	(kW)	1~	3~	1~	3~	0	1,5	3,0	4,5	6,0	7,5	9,0	10,5	12	13,5	15,0	16,5				
						50 Hz	50 Hz	0	25	50	75	100	125	150	175	200	225	250	275				
								H (m)															
CB 400	-	4	3	4,3	-	19,0	-	64,4	62,7	60,8	58,3	55,6	52,6	48,7	43,5	37,9	-	-	-	-			
-	CBT 400	4	3	-	4,6	-	7,9	66,9	65,2	63,3	61	58,4	55,2	51,5	47,8	44,3	40,1	-	-	-			
CB 600	-	5,5	4,0	5,7	-	26,0	-	80,4	79,1	77,1	74,5	71,8	68,4	64	59,2	54,1	-	-	-	-			
-	CBT 600	5,5	4,0	-	5,6	-	9,8	80,4	79,1	77,1	75	72,2	69,4	66	62,4	58,6	54,5	-	-	-			
-	CBT 751	7,5	5,5	-	6,8	-	11,6	89,5	88,3	86,7	84,1	81,3	78,3	74,7	71,1	66,9	61,3	55	-	-			
-	CBT 900	9	6,6	-	7,6	-	13,2	94,2	93,8	92,8	91,2	88,7	85,7	82,5	79,1	75	69,4	63	56	-			

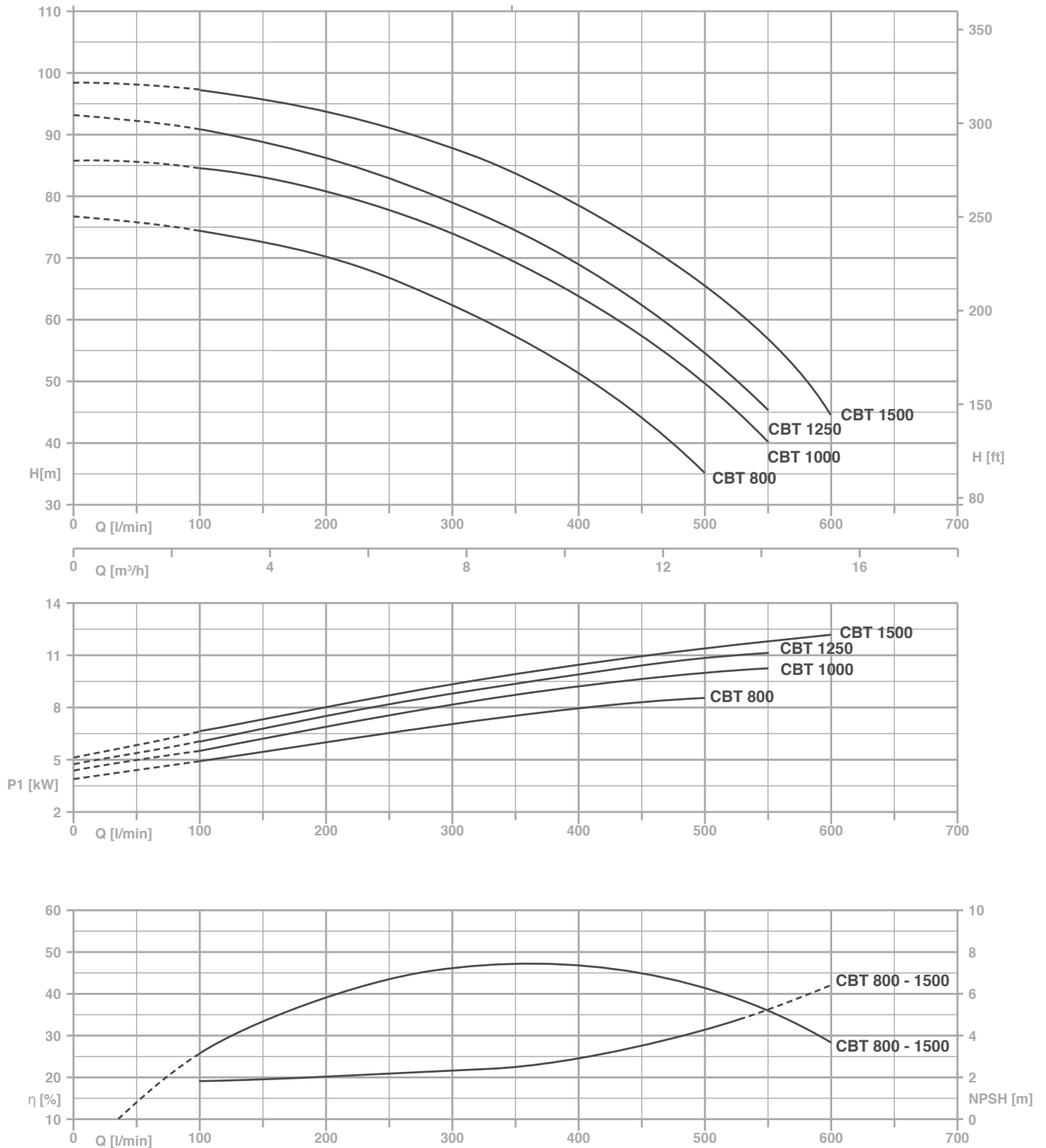

# CENTRIFUGALPUMPE CB SERIE

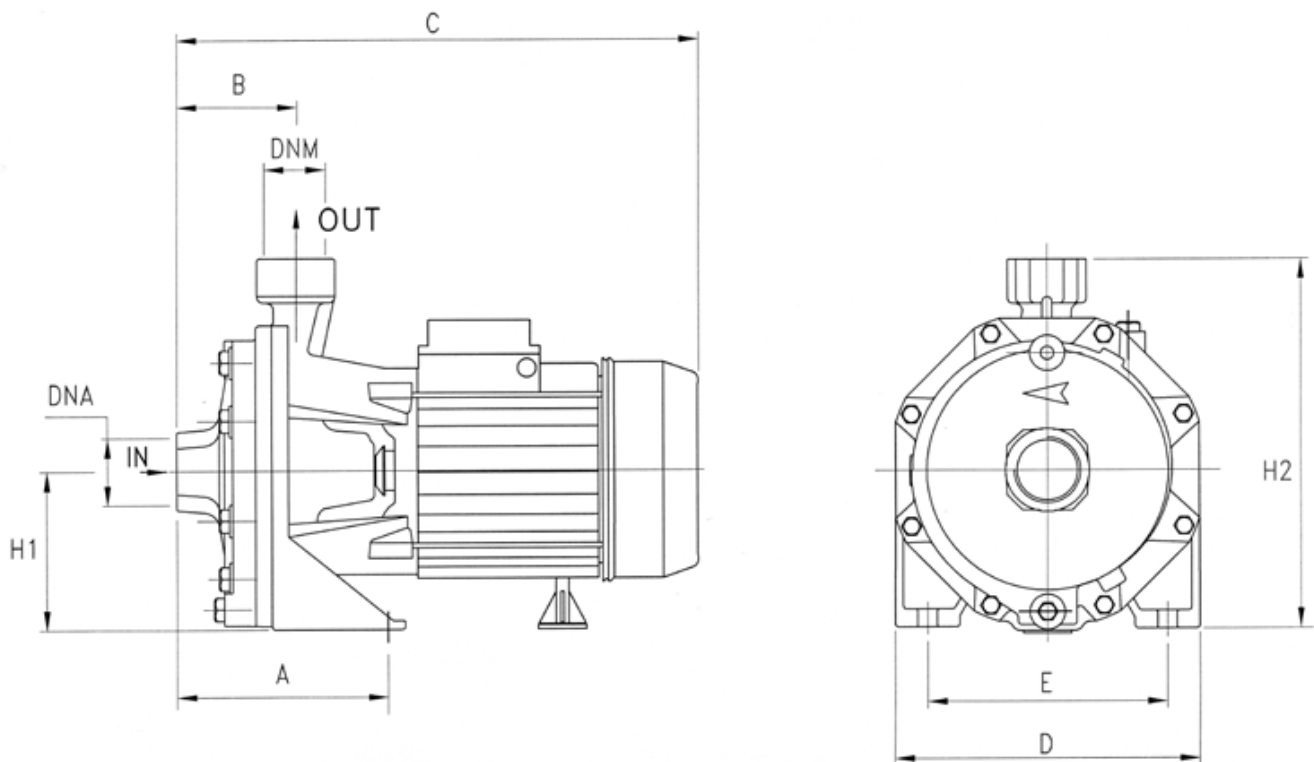

TYPE	P2		P1 (kW)	AMPERE	Q (m³/h - l/min)							
					3~							
					0	6	12	18	24	30	33	36
3~				3~	0	100	200	300	400	500	550	600
	(HP)	(kW)	3~	3x400 V 50 Hz	H (m)							
<b>CBT 800</b>	7,5	5,5	8,5	15	77,0	76,4	70,5	62,8	51,6	36,0	-	-
<b>CBT 1000</b>	10	7,5	10,3	17,2	86,4	84,8	80,7	74,3	64,0	50,2	40,4	-
<b>CBT 1250</b>	12,5	9,2	11,1	18,9	93,6	91,0	86,3	79,7	68,5	55,2	46,0	-
<b>CBT 1500</b>	15	11	12,1	20,4	98,7	97,6	94,2	87,6	78,2	65,6	57,5	40,9

## CENTRIFUGALPUMPE CB SERIE



TYPE	DIMENSIONS (mm)													
	A	B	C	D	E	H1	H2	DNA	DNM	I	L	M		
CB 100	122	72	328	180	140	98	228	1" G	1" G	350	195	265	15.3	
CB 160	115	82	385	210	170	110	265	1" 1/4 G	1" G	405	225	295	24.7	
CB 210	115	82	385	210	170	110	265	1" 1/4 G	1" G	405	225	295	25.6	
CB 310	115	82	385	210	170	110	265	1" 1/4 G	1" G	405	225	295	25.6	
CB 400	145	95,5	463	266	212	135	305	1" 1/2 G	1" 1/4 G	500	275	350	41	
CB 600	145	95,5	463	266	212	135	305	1" 1/2 G	1" 1/4 G	500	275	350	44.8	
CB 751	145	95,5	480	266	212	135	305	1" 1/2 G	1" 1/4 G	500	275	350	50.5	
CB 900	145	95,5	480	266	212	135	305	1" 1/2 G	1" 1/4 G	500	275	350	55	
CB 800	190	120	605	275	210	150	330	2" G	1" 1/4 G	640	310	370	70.5	
CB 1000	190	120	605	275	210	150	330	2" G	1" 1/4 G	640	310	370	77	
CB 1250	190	120	645	275	210	150	330	2" G	1" 1/4 G	640	310	370	85	
CB 1500	190	120	645	275	210	150	330	2" G	1" 1/4 G	640	310	370	92	