

# CS SERIE 75/2"-550/4"

## CENTRIFUGALPUMPE

- 0,59-4,0 kW el-motor, monoblokkoblet, 1x230/3x400V
- Ydelse: 300-1.600 l/min.
- Løftehøjde: 10-20 m. VS
- Tryk 6 bar
- Max. temperatur 90°C
- 2"-4" tilslutning
- Støbejern
- Vægt 14-41 kg.
- Velegnet til anvendelser, hvor der kræves høj ydelse.



# CENTRIFUGALPUMPE CS/CSB SERIE

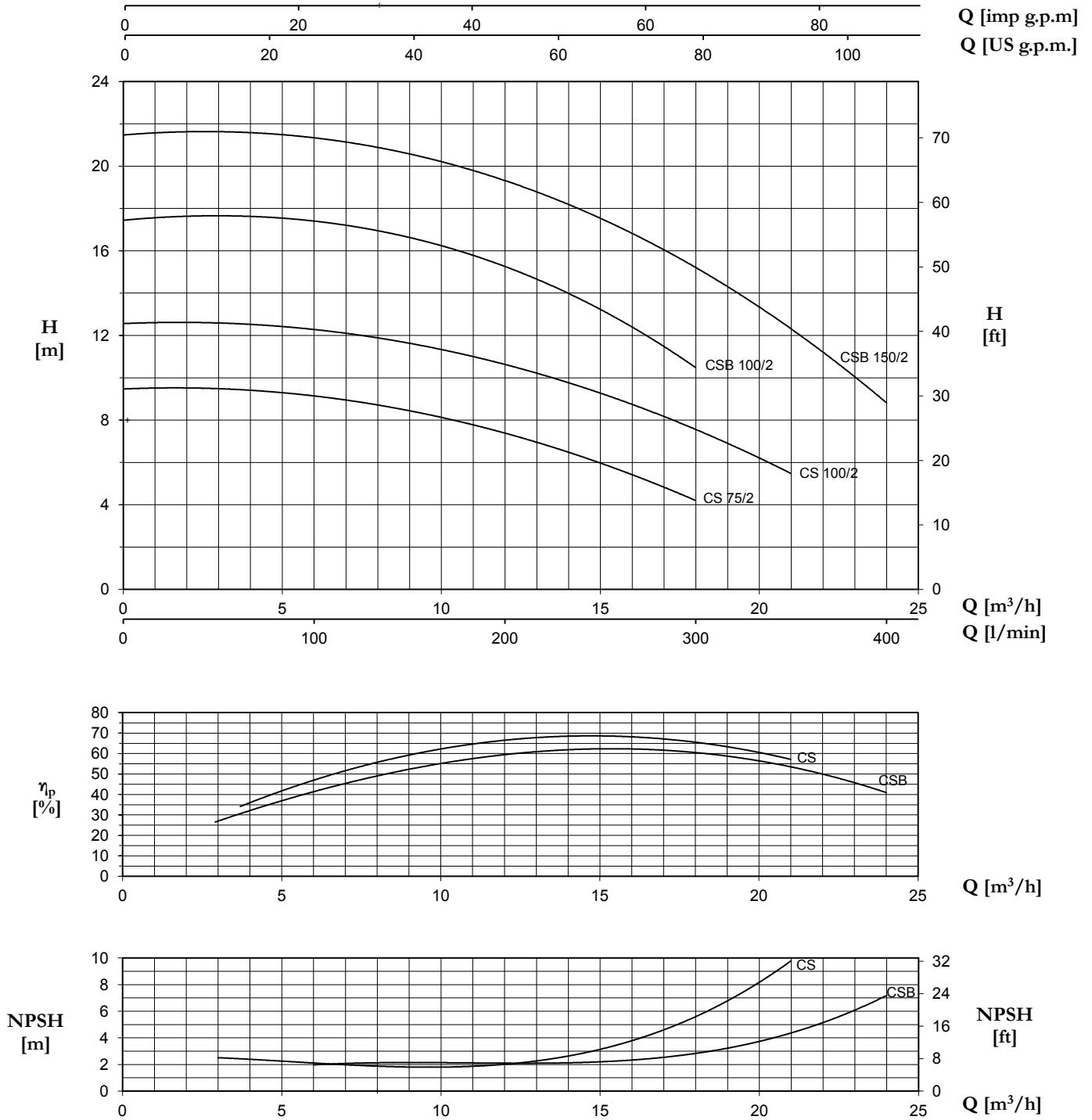

TYPE		P2		P1 (kW)		AMPERE		Q (m³/h - l/min)								
1~	3~	(HP)	(kW)	1~	3~	1~	3~	0	3	6	9	12	15	18	21	24
						50 Hz	50 Hz	0	50	100	150	200	250	300	350	400
								H (m)								
CS 75/2	CST 75/2	0,8	0,59	0,63	0,7	2,9	1,3	9,5	9,4	9,2	8,5	7,3	6	4,2	-	-
CS 100/2	CST 100/2	1	0,74	0,92	1,05	4,3	2,3	12,6	12,5	12,3	11,7	10,6	9,3	7,5	5,5	-
CSB 100/2	-	1	0,74	1,23	-	6	-	17,5	17,5	17,5	16,7	15,2	13,2	10,5	-	-
CSB 150/2	CSBT 150/2	1,5	1,1	1,78	1,65	8,5	3	21,5	21,5	21,5	20,6	19,2	17,5	15,3	12,3	8,8

# CENTRIFUGALPUMPE CS/CSB SERIE

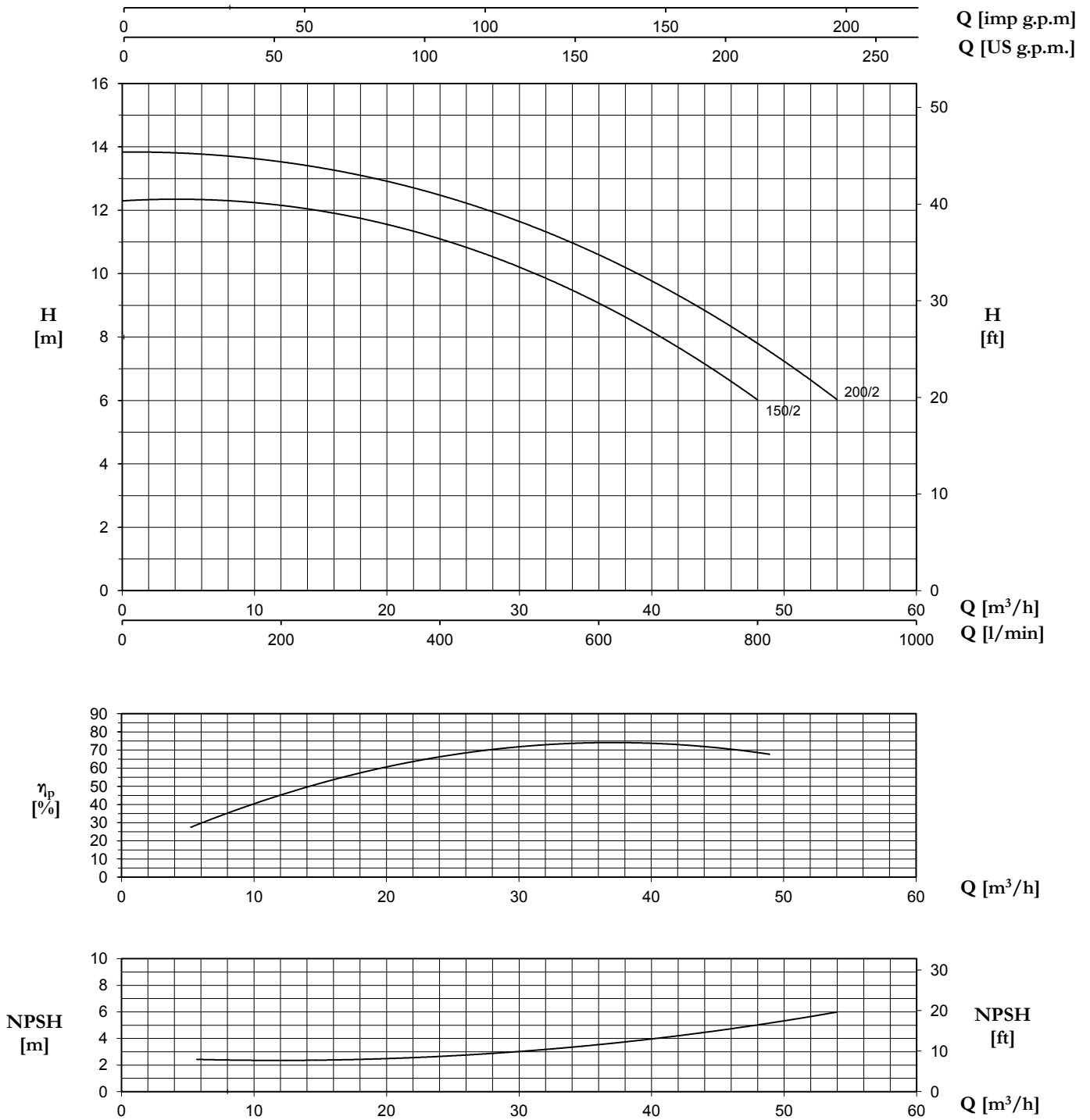

TYPE		P2		P1 (kW)		AMPERE		Q (m³/h - l/min)									
1~	3~	(HP)	(kW)	1~	3~	1~	3~	0	6	12	18	24	30	36	42	48	54
								0	100	200	300	400	500	600	700	800	900
								H (m)									
CS 150/2	CST 150/2	1,5	1,1	1,85	1,8	8,8	3,3	12,3	12,3	12,2	11,8	11,0	10,2	9,1	7,7	6	-
CS 200/2	CST 200/2	2	1,5	2,1	2,1	10	3,9	13,8	13,8	13,6	13,1	12,4	11,6	10,6	9,4	7,8	6

# CENTRIFUGALPUMPE CS/CSB SERIE

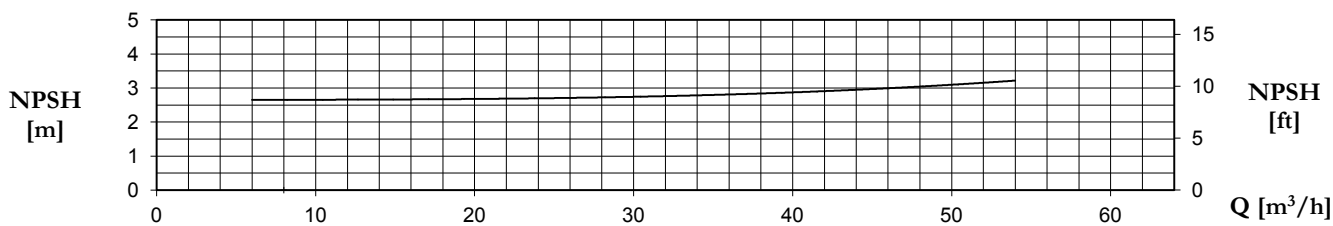
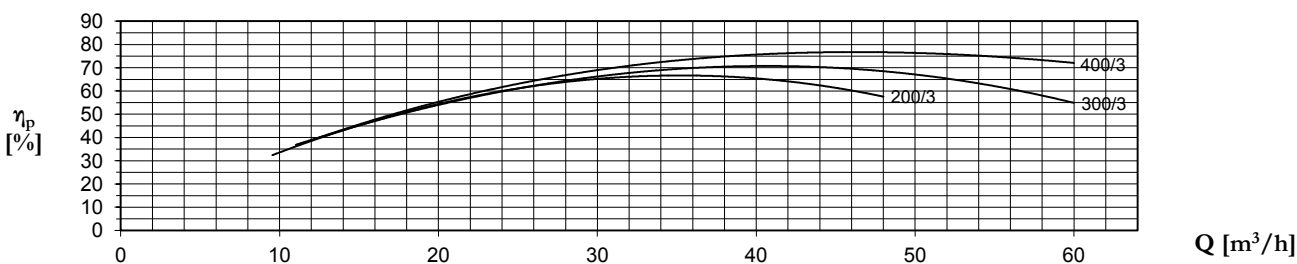
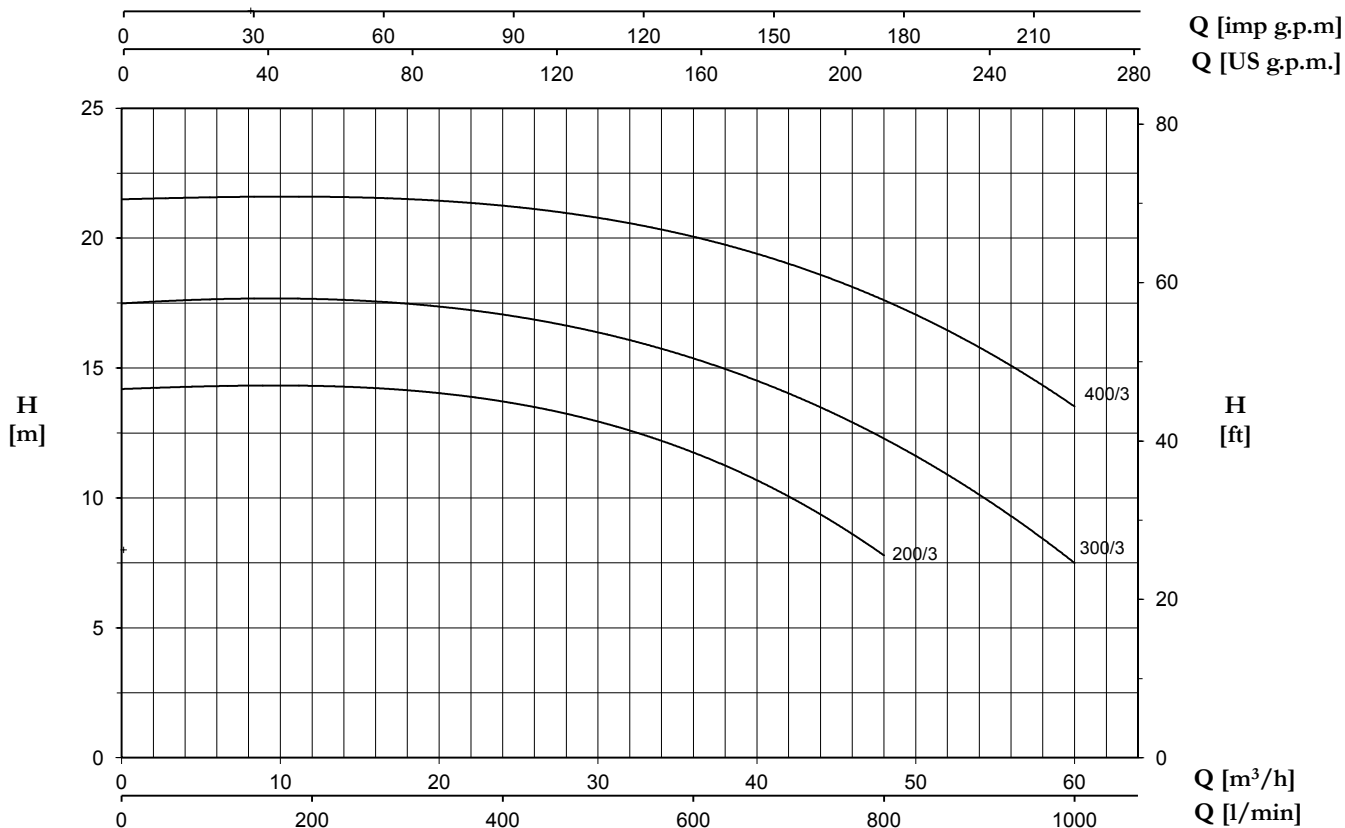

TYPE		P2		P1 (kW)		AMPERE		Q (m³/h - l/min)					
1~	3~	(HP)	(kW)	1~	3~	1~	3~	0	15	24	36	48	60
								0	250	400	600	800	1000
								H (m)					
						1x230 V 50 Hz	3x400 V 50 Hz						
CS 200/3	CST 200/3	2	1,5	2,35	2,15	11	3,6	14,2	14,2	13,8	11,7	7,8	-
CS 300/3	CST 300/3	3	2,2	3,3	2,9	15	4,9	17,5	17,5	17,2	15,3	12,3	7,5
-	CST 400/3	4	3	-	4	-	6,7	21,5	21,5	21,4	19,9	17,7	13,5

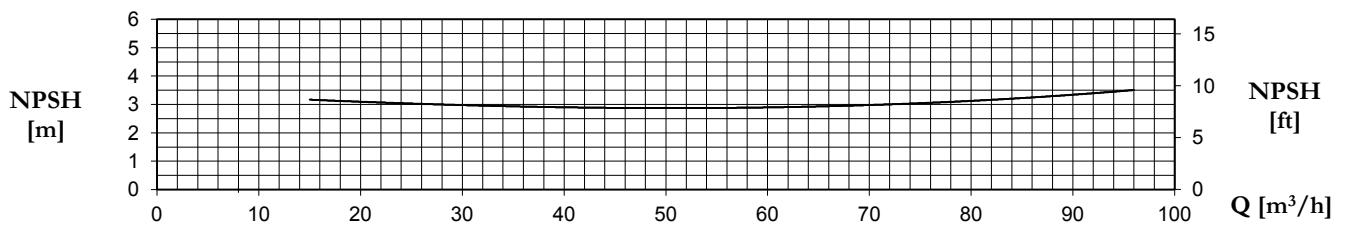
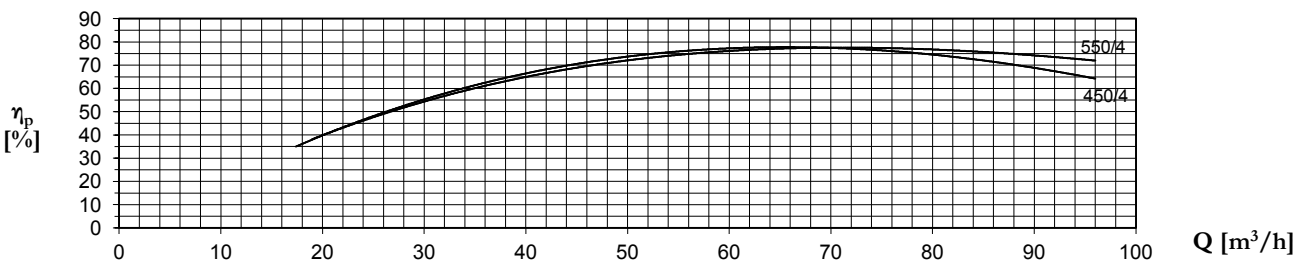
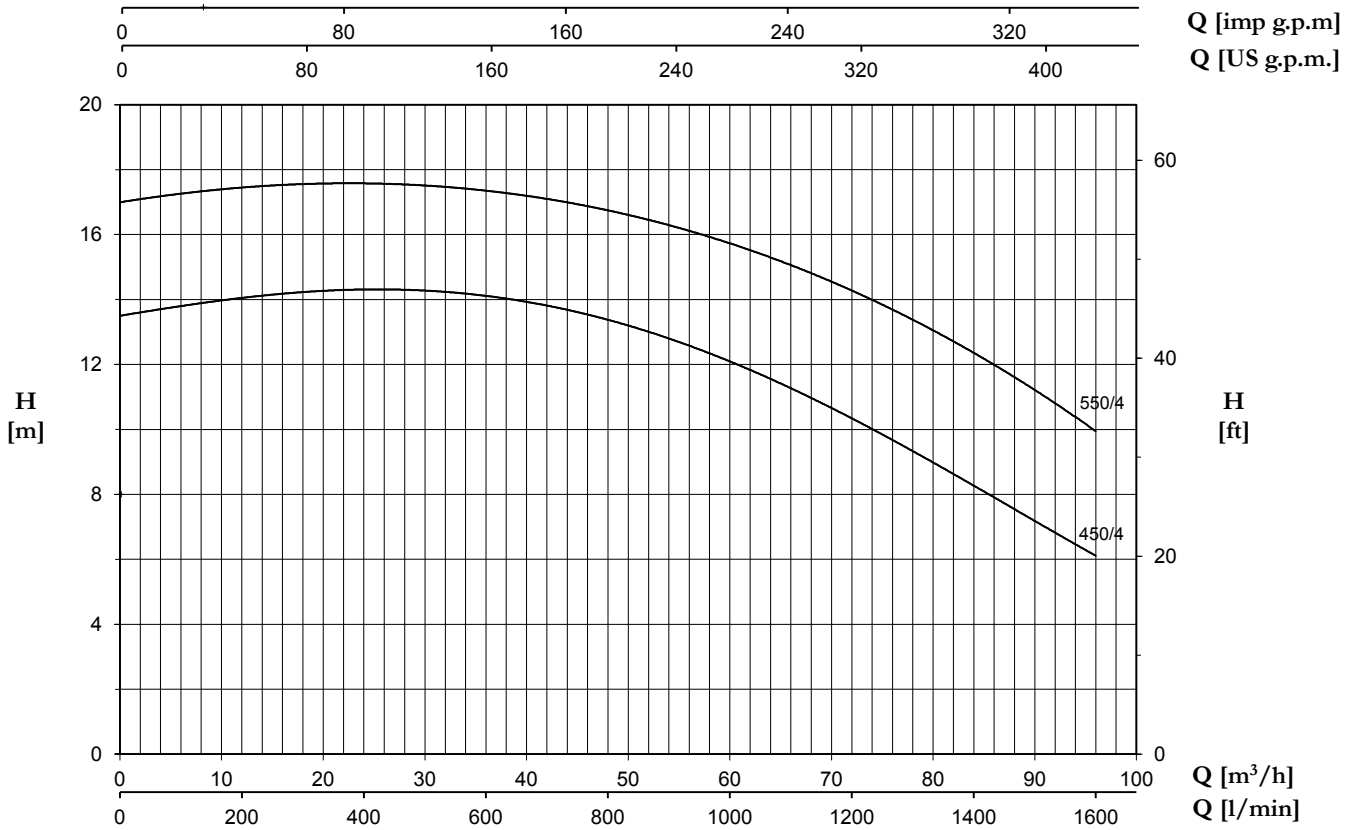

# CENTRIFUGALPUMPE CS/CSB SERIE

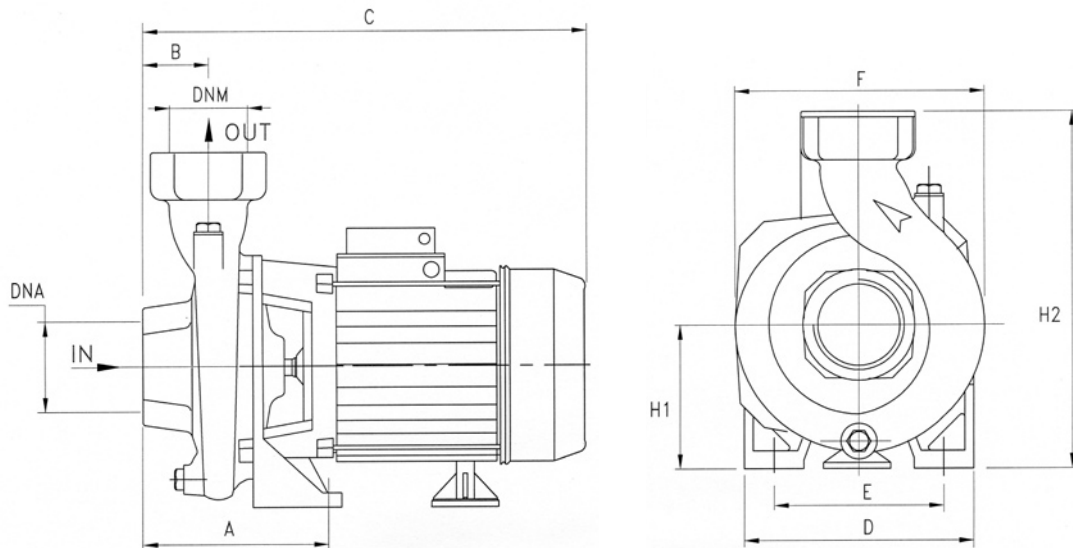

TYPE		P2		P1 (kW)		AMPERE		Q (m³/h - l/min)						
1~	3~	(HP)	(kW)	1~	3~	1~	3~	0	36	48	60	72	84	96
								0	600	800	1000	1200	1400	1600
						1x230 V 50 Hz		3x400 V 50 Hz		H (m)				
CS 450/4	CST 450/4	4	3	3,7	3,6	18	6,2	13,5	14,1	13,4	12,1	10,3	8,3	6,1
-	CST 550/4	5,5	4	-	5,05	-	8,8	17	17,3	16,8	15,7	14,4	12,2	10,0

## CENTRIFUGALPUMPE CS/CSB SERIE



TYPE	DIMENSIONS (mm)													 Kg
	A	B	C	D	E	F	H1	H2	DNA	DNM	I	L	M	
CS 75/2	127	45	315	155	115	178	97	247	2" G	2" G	340	195	280	14.2
CS 100/2	127	45	315	155	115	178	97	247	2" G	2" G	340	195	280	15.5
CS 150/2	150	53	370	180	140	218	115	285	2" G	2" G	390	230	325	23.3
CS 200/2	150	53	370	180	140	218	115	285	2" G	2" G	390	230	325	24.3
CSB 100/2	130	70	365	180	130	195	90	240	2" G	2" G	390	230	325	18.2
CSB 150/2	130	70	365	180	130	195	90	240	2" G	2" G	390	230	325	19.1
CS 200/3	176,5	80	455	200	140	225	112	292	3" G	3" G	480	245	330	28.3
CS 300/3	176,5	80	455	200	140	225	112	292	3" G	3" G	480	245	330	31.5
CST 400/3	176,5	80	455	200	140	225	112	292	3" G	3" G	480	245	330	31.6
CST 450/4	165	85	480	220	160	250	130	330	4" G	4" G	510	275	365	41.1
CST 550/4	165	85	480	220	160	250	130	330	4" G	4" G	510	275	365	41.1

TYPE				
	TRUCK		CONTAINER	
	PALLET (cm)	N° pumps	PALLET (cm)	N° pumps
CS 75-100	90x110x145	65	90x110x195	91
CS 150-200/2	85x110x140	40	85x110x205	60
CS 200-300/3	85x110x150	30	85x110x180	60
CS 450-550/4	80x120x150	30	80x120x180	60